

M12 FEMALE 0° SHIELDED

PVC 12x0,14 shielded black 20m

Female straight

M12, 12-pole

shielded

with cable sleeves

Plastic housings with good resistance against chemicals and oils.

The resistance to aggressive media should be individually tested for your application. Further details on request.

Further cable lengths on request.

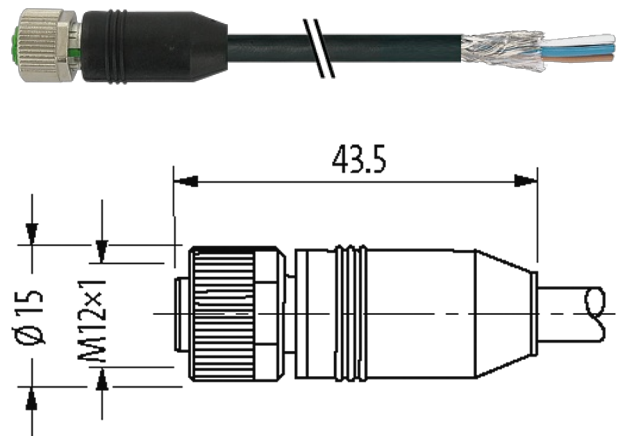
[Link to Product](#)**Illustration**

Product may differ from Image

Approvals

cCSAus

* only for products with UL/CSA approved cable

Form

Form 19341

General data

Standards	DIN EN 61076-2-101 (M12)
Pollution Degree	3
Mounting method	inserted, tightened
Material (contact)	Copper alloy
Material (contact surface)	Au
Material (gasket)	FKM
Temperature range	-25...+85 °C, depending on cable quality

Cables

No./diameter of wires	12× 0.14 mm ²
Wire isolation	PVC (br, bl, wh, gn, pk, ye, bk, gr, rd, vi, grpk, rdbl)
Outer Ø	6.5 mm ±5%
Temperature range (fixed)	-30...+80 °C
Temperature range (mobile)	-5...+80 °C
Cable identification	703

Cable Type	1 (PVC)
Approval (cable)	cURus (AWM-Style 2464/173)
Cable weight [g/m]	73,70
Resistor (core)	max. 138 Ω /km (20 °C)
Material (wire)	Cu wire, bare
Single wire \varnothing (core)	0.1 mm
Construction (core)	18× 0.1 mm (multi-strand wire class 5)
Diameter (core)	12× 0.14 mm ²
AWG	similar to AWG 26
Material (wire isolation)	PVC
Material property (wire isolation)	CFC-, cadmium-, silicone- and lead-free, matt, low-adhesion, machine easy to process, abrasion-resistant
Shore hardness (wire isolation)	45 \pm 5 D
Wire- \varnothing incl. isolation	1.05 mm \pm 5%
Color/numbering of wires	br, rd, gr, bk, ye, pk, gn, wh, bl, rdbl, grpk, vi
Stranding combination	Twisted wires rdbl, grpk and vi, over it all other wires are twisted
Shield	yes
Material (jacket)	PVC
Material property (jacket)	CFC-, cadmium-, silicone- and lead-free, matt, low-adhesion, machine easy to process, abrasion-resistant
Shore hardness (jacket)	85 \pm 5 A
Outer- \varnothing (jacket)	6.5 mm \pm 5%
Color (jacket)	black
chemical resistance	good resistance to oil, gasoline and chemicals
thermal resistance	flame retardant UL 1581 VW1 / CSA FT1
Nominal voltage	UL 300 V AC
Test voltage	2000 V
Current load capacity	to DIN VDE 0298-4
Temperature range (fixed)	-30...+80 °C
Temperature range (mobile)	-5...+80 °C
Bend radius (fixed)	10× outer \varnothing
Bend radius (moving)	10× outer \varnothing
Jacket Color	black

Technical Data

Operating voltage	max. 30 V AC/DC
Rated surge voltage	0.8 kV
Operating current per contact	max. 1.5 A
Material group	IEC 60664-1, category I
No. of poles	12
Coding	A-coded
Locking of ports	Screw thread (M12×1 mm) recommended torque 0.6 Nm, self-securing
Compression gland	M12 (SW13)
Protection	IP67 inserted and tightened (EN 60529)
Locking material	Zinc die casting, matte nickel plated
Material	PUR
suitable for corrugated tube (internal \varnothing)	without

Commercial data

country of origin	DE
customs tariff number	85444290
EAN	4048879477710

eClass 27279218

Packaging unit 1

Sketch

1	▷	brown
2	▷	blue
3	▷	white
4	▷	green
5	▷	pink
6	▷	yellow
7	▷	black
8	▷	gray
9	▷	red
10	▷	violet
11	▷	gray/pink
12	▷	red/blue
		shield

Female

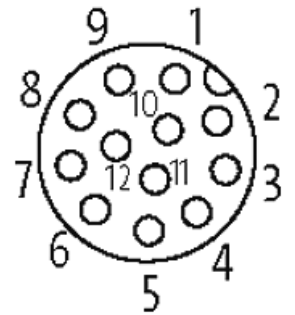

Product may differ from Image